

FLUKE®

63/66/68

Infrared Thermometers

Users Manual

PN 2149032
September 2004 Rev.2, 7/05
© 2004-2005 Fluke Corporation, All rights reserved. Printed in China
All product names are trademarks of their respective companies.

LIMITED WARRANTY AND LIMITATION OF LIABILITY

This Fluke product will be free from defects in material and workmanship for two years from the date of purchase. This warranty does not cover fuses, disposable batteries, or damage from accident, neglect, misuse, alteration, contamination, or abnormal conditions of operation or handling. Resellers are not authorized to extend any other warranty on Fluke's behalf. To obtain service during the warranty period, contact your nearest Fluke authorized service center to obtain return authorization information, then send the product to that Service Center with a description of the problem.

THIS WARRANTY IS YOUR ONLY REMEDY. NO OTHER WARRANTIES, SUCH AS FITNESS FOR A PARTICULAR PURPOSE, ARE EXPRESSED OR IMPLIED. FLUKE IS NOT LIABLE FOR ANY SPECIAL, INDIRECT, INCIDENTAL OR CONSEQUENTIAL DAMAGES OR LOSSES, ARISING FROM ANY CAUSE OR THEORY. Since some states or countries do not allow the exclusion or limitation of an implied warranty or of incidental or consequential damages, this limitation of liability may not apply to you.

Fluke Corporation
P.O. Box 9090
Everett, WA 98206-9090
U.S.A.

Fluke Europe B.V.
P.O. Box 1186
5602 BD Eindhoven
The Netherlands

11/99

Table of Contents

Title	Page
Introduction.....	1
Contacting Fluke	1
Safety Information	2
Symbols and Safety Markings.....	3
Features	5
Display	7
Display (63).....	8
Display (66/68).....	8
Buttons (66/68).....	9
How the Thermometers Work.....	9
Operating the Thermometer	10
Temperature Measurement.....	10
Locating a Hot or Cold Spot.....	10
Distance and Spot Size.....	11
Field of View	13
Emissivity	13
Switching °C and °F	15
Trigger Lock (66/68).....	15
Backlight and Laser On/Off Switch (63)	16
Function Button Functions (66/68)	16
Selecting a Function (66/68)	17
Setting the High Alarm, Low Alarm, and Emissivity (66/68).....	18

63/66/68

Infrared Thermometers

Using a Contact Temperature Probe (PRB) (66/68)	18
HOLD	19
Storing Data (66/68)	19
Recalling Data (66/68)	19
LOG Clear Function	19
Maintenance	20
Changing the Battery	20
Cleaning the Lens	20
Cleaning the Housing	20
Troubleshooting	21
Accessories	21
CE Certification	22
Specifications	22

63/66/68

Introduction

The Fluke Models 63, 66, and 68 Infrared Thermometers (“the thermometers”) are for non-contact temperature measurement. These thermometers determine an object’s surface temperature by measuring the amount of infrared energy radiated by the object’s surface. See Figure 2.

Contacting Fluke

To contact Fluke, call one of the following telephone numbers:

USA: 1-888-44-FLUKE (1-888-443-5853)

Canada: 1-800-36-FLUKE (1-800-363-5853)

Europe: +31 402-675-200

Japan: +81-3-3434-0181

Singapore: +65-738-5655

Anywhere in the world: +1-425-446-5500

For USA Service: 1-888-99-FLUKE (1-888-993-5853)

Or, visit Fluke’s Web site at www.fluke.com.

To register your product, visit register.fluke.com.

Safety Information

⚠ ⚠ Warning

A Warning identifies conditions and actions that pose hazards to the user. To avoid electrical shock or personal injury, follow these guidelines:

- **⚠ Do not point laser directly at eye or indirectly off reflective surfaces.**
- **Before using the thermometer inspect the case. Do not use the thermometer if it appears damaged. Look for cracks or missing plastic.**
- **Replace the batteries as soon as the battery indicator (🔋) appears.**
- **Do not use the thermometer if it operates abnormally. Protection may be impaired. When in doubt, have the thermometer serviced.**
- **Do not operate the thermometer around explosive gas, vapor, or dust.**
- **Do not connect the optional external probe to live electrical circuits.**
- **To avoid a burn hazard, remember that highly reflective objects will result in lower than actual temperature measurements.**
- **Do not use in a manner not specified by this manual or the protection supplied by the equipment may be impaired.**

⚠ Caution





To avoid damaging the thermometer or the equipment under test protect them from the following:

- **EMF (electro-magnetic fields) from arc welders, induction heaters, etc.**
- **Static electricity**
- **Thermal shock (caused by large or abrupt ambient temperature changes- allow 30 minutes for thermometer to stabilize before use).**
- **Do not leave the thermometer on or near objects of high temperature.**

Symbols and Safety Markings

Table 1 and Figure 1 show various symbols and safety markings that are on the thermometers and in this manual.

Table 1. Symbols

Symbol	Explanation
	Risk of danger. Important information. See Manual.
	Hazardous voltage. Precedes warning
	Warning. Laser.
CE	Conforms to requirements of European Union and European Free Trade Association (EFTA)
°C	Celsius
°F	Fahrenheit
	Battery

63/66/68
Infrared Thermometers

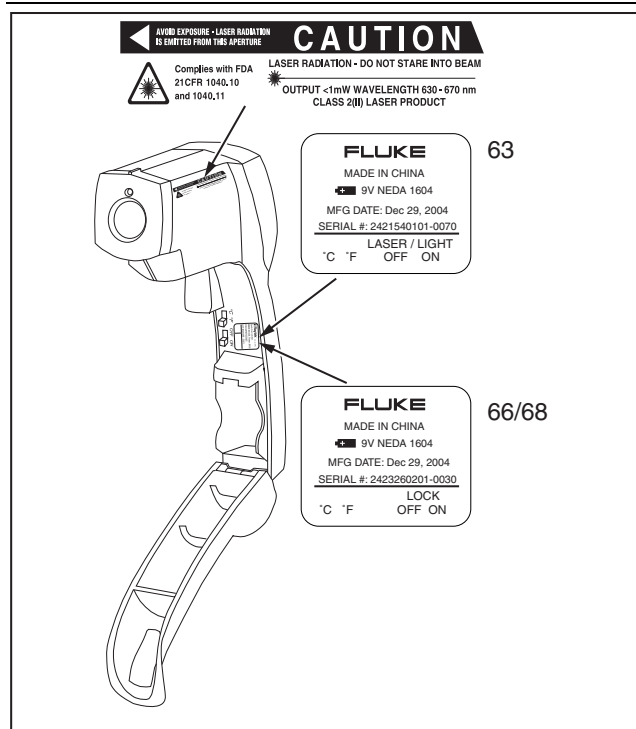

ame0010.eps

Figure 1. Safety Markings on the Thermometers

Features

The thermometers include:

- Single-spot laser sighting
- MAX temperature display
- Backlit display
- Durable, ergonomic construction
- Tripod mount
- Hard case and wrist strap
- MAX, MIN, DIF, AVG temperature displays (66/68)
- Adjustable emissivity (66/68)
- High and low alarm (66/68)
- Data logging (66/68)
- Trigger Lock (66/68)
- Contact probe jack (66/68)

63/66/68
Infrared Thermometers

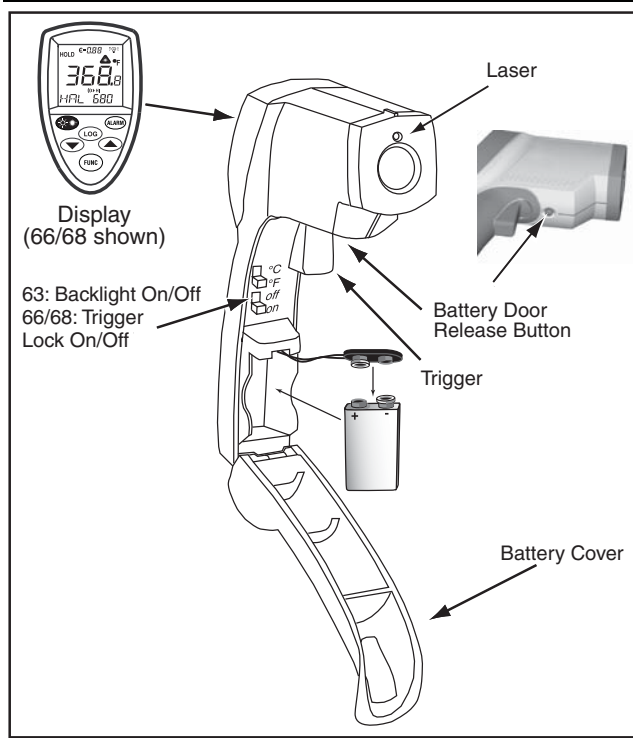
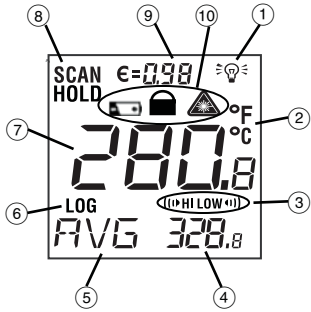

Figure 2. Infrared Thermometer

ame007.eps

Display

The diagram shows a digital display with the following elements:

- ①: A small 'On' symbol in the top right corner.
- ②: '°C/°F' symbols on the right side of the display.
- ③: 'HI' and 'LOW' symbols with arrows pointing left and right, respectively, located below the main temperature reading.
- ④: The main temperature reading '280.8'.
- ⑤: A small icon below the main temperature reading.
- ⑥: 'LOG' text below the main temperature reading.
- ⑦: The average temperature reading 'AVG 328.8'.
- ⑧: 'SCAN' and 'HOLD' text in the top left corner.
- ⑨: 'ε=0.98' emissivity value in the top left corner.
- ⑩: 'Low Battery' and 'Laser On' symbols in the top left corner.

ame001.eps

①	Backlight "On" symbol (63/66/68)
②	°C/°F symbol (Celsius/Fahrenheit) (63/66/68)
③	High alarm and low alarm symbol (66/68)
④	Maximum temperature display (63) Temperature values for the MAX, MIN, DIF, AVG, HAL, LAL, PRB (66/68)
⑤	Icon for MAX (63/66/68) Icon for MIN, DIF, AVG, HAL, LAL, PRB (66/68)
⑥	LOG icon shows log mode for data storage (66/68)
⑦	Live temperature value (63/66/68)
⑧	SCAN or HOLD (63/66/68)
⑨	Emissivity symbol and value (63/66/68)
⑩	Low Battery and Laser "On" symbols (63/66/68) Lock symbol (66/68)

63/66/68

Infrared Thermometers

Display (63)

In the SCAN mode, the backlit reading displays both the live temperature (7) and maximum temperature (4) in Celsius or Fahrenheit (2). The thermometer holds the last reading for 7 seconds after the trigger is released and "HOLD" appears (8).

Display (66/68)





In SCAN mode, both the live temperature (7) and the selected mode function (4,5) are displayed in Celsius or Fahrenheit (2). The thermometer holds the last reading for 7 seconds after the trigger is released and "HOLD" appears (8).

Notes

For all units, when the battery is low,  appears but the thermometer will no longer function.

For the 66/68, to activate the laser and backlight, pull the trigger. Press  once to activate the backlight, twice to turn both laser and backlight on, and a third time to turn them off.

Buttons (66/68)

	Sets high and low alarm
	Up and down
	Cycles through the function loop
	Laser/Backlight on/off button (pull trigger and press button to activate laser/backlight)
	LOG button (for storing data)

How the Thermometers Work

Infrared thermometers measure the surface temperature of an opaque object. The thermometer's optics sense emitted, reflected, and transmitted energy, which is collected and focused onto a detector. The unit's electronics translate the information into a temperature reading which the unit displays. The laser is used for aiming purposes only. See Figure 3.

63/66/68

Infrared Thermometers

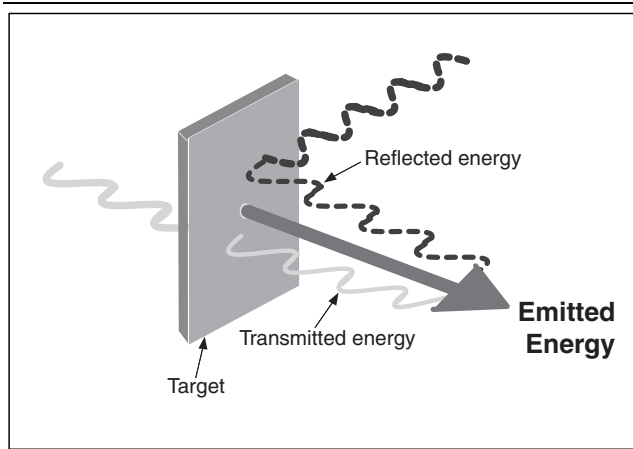

Figure 3. How the Thermometer Works

ame002.eps

Operating the Thermometer

Temperature Measurement

To measure temperature, point the unit at an object and pull the trigger. Be sure to consider distance-to-spot size ratio and field of view. The laser is used for aiming only.

Locating a Hot or Cold Spot

To find a hot or cold spot, aim the thermometer outside the desired area. Then, slowly scan across the area with an up and down motion until you locate the hot or cold spot. See Figure 4.

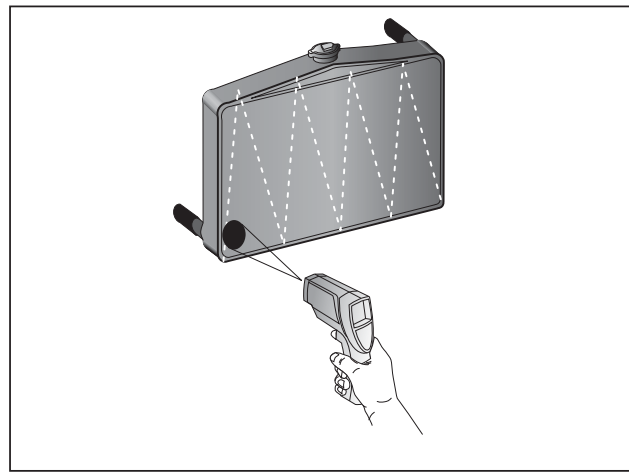

Figure 4. Locating a Hot or Cold Spot

ame003.eps

Distance and Spot Size

As the distance (D) from the object being measured increases, the spot size (S) of the area measured by the unit becomes larger. The relationship between distance and spot size for each unit is shown in Figure 5. The focal point of each unit is 914 mm (36 in). The spot sizes indicate 90 % encircled energy. See Figure 5.

63/66/68

Infrared Thermometers

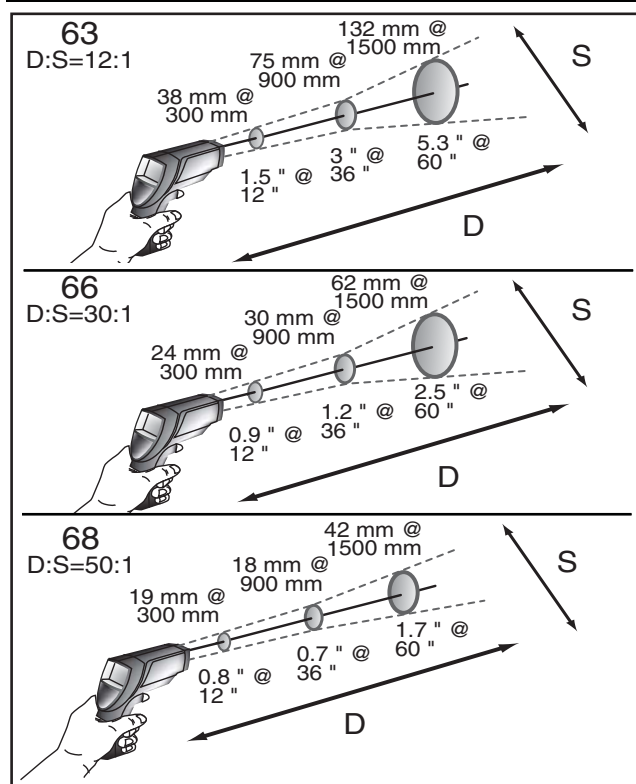

ame005.eps

Figure 5. Distance and Spot Size

Field of View

Make sure that the target is larger than the unit's spot size. The smaller the target, the closer you should be to it. See Figure 6.

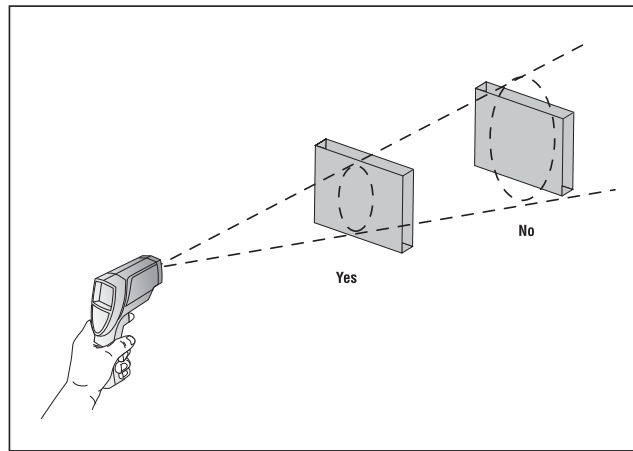

Figure 6. Field of View

ame004.eps

Emissivity

Emissivity describes the energy-emitting characteristics of materials. Most organic materials and painted or oxidized surfaces have an emissivity of 0.95.

The 63 has a preset emissivity of 0.95. To compensate for inaccurate readings that may result from measuring shiny metal surfaces, cover the surface to be measured with masking tape or flat black paint (< 148 °C/300 °F). Allow time for the tape or paint to reach the same temperature as the surface beneath it. Measure the temperature of the tape or painted surface.

63/66/68*Infrared Thermometers*

The 66/68 thermometers allow you to adjust the unit's emissivity for the type of surface being measured. Refer to Table 2.

Table 2. Surface Emissivity

Measured Surface	Emissivity	Measured Surface	Emissivity
METALS		Iron	
Aluminum		Oxidized	0.5-0.9
Oxidized	0.2-0.4	Rusted	0.5-0.7
Alloy A3003		Iron, Cast	
Oxidized	0.3	Oxidized	0.6-0.95
Roughened	0.1-0.3	Unoxidized	0.2
Brass		Molten	0.2-0.3
Burnished	0.3	Iron, Wrought	
Oxidized	0.5	Dull	0.9
Copper		Lead	
Oxidized	0.4-0.8	Rough	0.4
Electrical		Oxidized	0.2-0.6
Terminal Blocks	0.6	Molybdenum	
Haynes		Oxidized	0.2-0.6
Alloy	0.3-0.8	Nickel	
Inconel		Oxidized	0.2-0.5
Oxidized	0.7-0.95	Platinum	
Sandblasted	0.3-0.6	Black	0.9
Electropolished	0.15		

Table 2. Surface Emissivity (cont.)

Measured Surface	Emissivity	Measured Surface	Emissivity
Steel		Clay	0.95
Cold-Rolled	0.7-0.9	Concrete	0.95
Ground Sheet	0.4-0.6	Cloth	0.95
Polished Sheet	0.1	Glass	
Zinc		Plate	0.85
Oxidized	0.1	Gravel	0.95
NON-METALS		Gypsum	0.8-0.95
Asbestos	0.95	Ice	0.98
Asphalt	0.95	Limestone	0.98
Basalt	0.7	Paper	
Carbon		(any color)	0.95
Unoxidized	0.8-0.9	Plastic	
Graphite	0.7-0.8	Opaque	0.95
Carborundum	0.9	Soil	0.9-0.98
Ceramic	0.95	Water	0.93
		Wood, (natural)	0.9-0.95

Switching °C and °F

Open the unit by pushing the button on the underside of the thermometer near the trigger and pulling down and forward at the top of the handle.

To toggle between °C and °F, slide the top switch to the appropriate position. See Figure 2.

Trigger Lock (66/68)

To lock the unit on for continuous measurement, slide the bottom switch down. See Figure 2. If the trigger is pulled while the unit is locked on, the laser and backlight will turn on if they have been activated. When the unit is locked on, the laser will turn off when

63/66/68

Infrared Thermometers



the trigger is released. However, the backlight remains on unless it is turned off using the keypad.

Backlight and Laser On/Off Switch (63)

To turn the backlight and laser on or off, slide the backlight and laser switch to the appropriate position. See Figure 2.

Function Button Functions (66/68)

Models 66 and 68 measure Maximum (MAX), Minimum (MIN), Differential (DIF), and Average (AVG) temperatures each time a reading is taken. DIF shows the difference between maximum and minimum temperatures measured. AVG shows the average temperature reading for each time the trigger is pulled or the unit is locked on. This data is stored and can be recalled with  until a new measurement is taken. See "Hold" for information on how to recall stored data. When the trigger is pulled again, the unit will be measuring in the last mode selected.

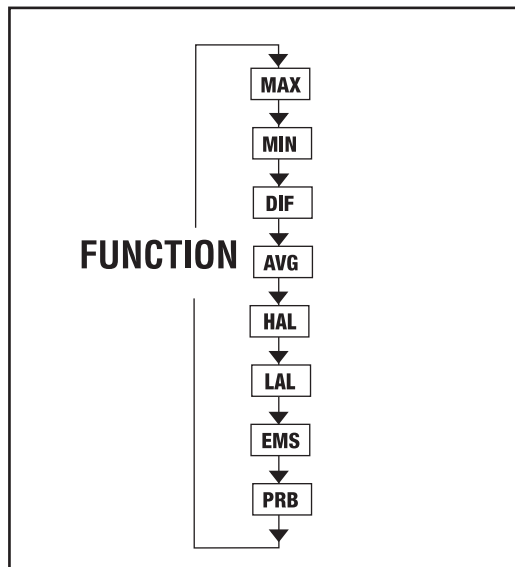

Pressing  also allows access to the High Alarm (HAL), Low Alarm (LAL), Emissivity (EMS), Probe temperature (PRB-only available when the probe is connected to the thermometer), and Data logger (LOG). Each time  is pressed the unit advances the function cycle. Figure 7 shows the sequence of functions in the function cycle.



ame006.eps

Figure 7. Function Cycle

Selecting a Function (66/68)

To select the MAX, MIN, DIF, or AVG mode, pull the trigger. While holding the trigger, press  until the appropriate icon appears in the lower left corner of the display. Each time  is pressed, the thermometer advances through the function cycle. The function cycle is shown in Figure 7.

63/66/68

Infrared Thermometers

Setting the High Alarm, Low Alarm, and Emissivity (66/68)

To set values for the High Alarm (HAL), Low Alarm (LAL), and Emissivity, pull the trigger or press **(FUNC)** to activate the display. Press **(FUNC)** until the appropriate icon appears in the lower left of the display. Use **(▲)** or **(▼)** to adjust the desired values. To activate the alarms, press **(ALARM)**. To deactivate the alarms, press **(ALARM)** again.

Using a Contact Temperature Probe (PRB) (66/68)

⚠ ⚠ Warning

To avoid electrical shock or personal injury, do not connect the optional external probe to live electrical circuits.

Connect the probe to the input on the side of the unit. PRB appears in the left of the display. The probe temperature appears in the lower right of the display. The live infrared temperature continues to show in the center of the display. While the probe is connected, you may still cycle through the mode functions by pressing **(FUNC)**. See Figure 8.

Note

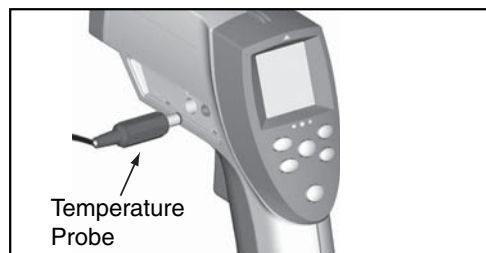

PRB is only available in the Function loop when a probe is connected to the unit. The probe temperature will not activate the high alarm or low alarm.



ame009.eps





Figure 8. Connecting a Temperature Probe

HOLD



The unit's display will remain activated for seven seconds after the trigger is released, unless the unit is locked on (lock on 66/68 only). HOLD appears in the upper left of the display. During HOLD or after the unit shuts off, recall stored values by pressing  without pulling the trigger (66/68). Each time  is pressed, the unit advances through the function cycle. When the trigger is pulled again, the unit will begin measuring in the last function selected.

Storing Data (66/68)

The thermometers are capable of storing up to 12 data locations. The infrared temperature, temperature scale (°C or °F), and emissivity are also stored.

To store data from an infrared reading, pull the trigger. While holding the trigger, press  until LOG appears in the lower left of the display. A log location number is shown below LOG. If no temperature has been recorded in the shown LOG location, 3 dashes will appear in the lower right corner. Aim the unit at the desired target and press . A tone confirms that the location temperature has been recorded. The recorded temperature appears in the lower right corner of the display. To select another log location, press  or .

Recalling Data (66/68)

Recall stored data after the unit shuts off by pressing  until LOG appears in the display's lower left corner. A LOG location is shown below LOG and the stored temperature for that location will be shown in the display's lower right corner. To move to another LOG location, press  or .

LOG Clear Function

The LOG Clear function allows you to quickly clear all logged data points. This function can only be used when the unit is in LOG mode. It can be used when the thermometer has any number of log locations stored.

63/66/68

Infrared Thermometers

Note

Only use the LOG Clear function if you want to clear all the LOG location data that is stored in the unit's memory.

To use LOG Clear, while in LOG mode, pull the trigger then press  until the unit reaches LOG location "0".

Note

This can only be done when the trigger is pulled. LOG location "0" cannot be accessed by using .

When LOG location "0" shows in the display's lower left corner, press . Three tones sound and the LOG location automatically changes to "1", signifying that all data locations have been cleared.

Maintenance

Changing the Battery

To install or change the 9 V battery, open the unit and attach the battery to the battery snaps with the positive side facing toward the rear of the battery compartment. See Figure 2.

Cleaning the Lens

Blow off loose particles using clean compressed air. Carefully wipe the surface with a moist cotton swab. The swab may be moistened with water.

Cleaning the Housing

Use soap and water on a damp sponge or soft cloth.

Caution

To avoid damaging the thermometers, do NOT submerge them in water.

Troubleshooting

Symptom	Problem	Action
--- (on display)	Target temperature is over or under range	Select target within specifications
	Low battery	Replace battery
Blank display	Possible dead battery	Check and/or replace battery
Laser does not work	1. Low or dead battery 2. Ambient temperature above 40 °C (104 °F)	1. Replace battery 2. Use in area with lower ambient temperature
ERR	Possible damage by EMF	Contact your distributor

Accessories

Optional accessories for the thermometers are:

- Contact probe (RTD) (66/68) - Fluke PN 2148313
- Nylon Soft Carrying Case – Fluke PN 2152040
- NIST/DKD certification

63/66/68

Infrared Thermometers

CE Certification

The thermometers conform to the following standards:

- EN61326-1 EMC
- EN61010-1
- EN60825-1 Safety

Certification testing was conducted using a frequency range of 80-1000 MHz with the instrument in three orientations.

Notes

63: Between 165 MHz and 880 MHz ($\pm 5\%$) at 3 V/m, the instrument may not meet its stated accuracy.

66/68: Between 162 MHz and 792 MHz ($\pm 5\%$) at 3 V/m, the instrument may not meet its stated accuracy.

Specifications

Temperature Range

Assumes ambient operating temperature of 23 °C (73 °F) to 25 °C (77 °F)

63:	-32 °C to 535 °C (-25 °F to 999 °F)
66:	-32 °C to 600 °C (-25 °F to 1100 °F)
68:	-32 °C to 760 °C (-25 °F to 1400 °F)

Accuracy

Target Temperature:

Above 510 °C (63)	$\pm 1.5\%$ of reading
Above 510 °C (66/68)	$\pm 1\%$ of reading or ± 1 °C (± 2 °F), whichever is greater
23 °C to 510 °C	$\pm 1\%$ of reading or ± 1 °C (± 2 °F), whichever is greater
-18 °C to 23 °C	± 2 °C (± 3 °F)
-26 °C to -18 °C	± 2.5 °C (± 4 °F)
-32 °C to -26 °C	± 3 °C (± 5 °F)

Resolution

63:	0.2 °C (0.5 °F)
66/68:	0.1 °C (0.1 °F)

63/66/68
Specifications

Distance to Spot Ratio

63: 12:1
66: 30:1
68: 50:1

Emissivity

(Adjustment for surface measured)

63: Pre-set at 0.95
66/68: Digitally adjustable from 0.10 to 1.0

Response Time

500 mSec

Repeatability

±0.5 % of reading or ±1 °C (±2 °F), whichever is greater

Spectral Response

8 μm to 14 μm

Laser Sighting

Laser turns off above ambient temperature of 40 °C (104 °F)

Relative Humidity

10 % to 90 % RH non-condensing, at < 30 °C (86 °F)

Tripod Mount

¼ in. 20 UNC threading

Operating Temperature

0 °C to 50 °C (32 °F to 120 °F)

Storage Temperature

0 °C to 50 °C (32 °F to 120 °F)

Weight

320 g (.7 lbs)

Dimensions

200 mm x 160 mm x 55 mm (7.8 in x 6.30 in x 2.17 in)

Battery Type

9 V Alkaline or NiCd

Battery Life

63: 10 hours with laser and backlight on
40 hours with laser and backlight off
66/68: 20 hours with laser and backlight on
40 hours with laser and backlight off

63/66/68

Infrared Thermometers

Optional Contact Probe (66/68)

Temperature Range -40 °C to 260 °C (-40 °F to 500 °F)

Accuracy

(Assumes ambient operating temperature of 23 °C (73 °F) to 25 °C (77 °F))

±1% of reading or ±1°C (±2°F), whichever is greater

Certifications: CE,



京制00000298号